

Power Quality Application Guide

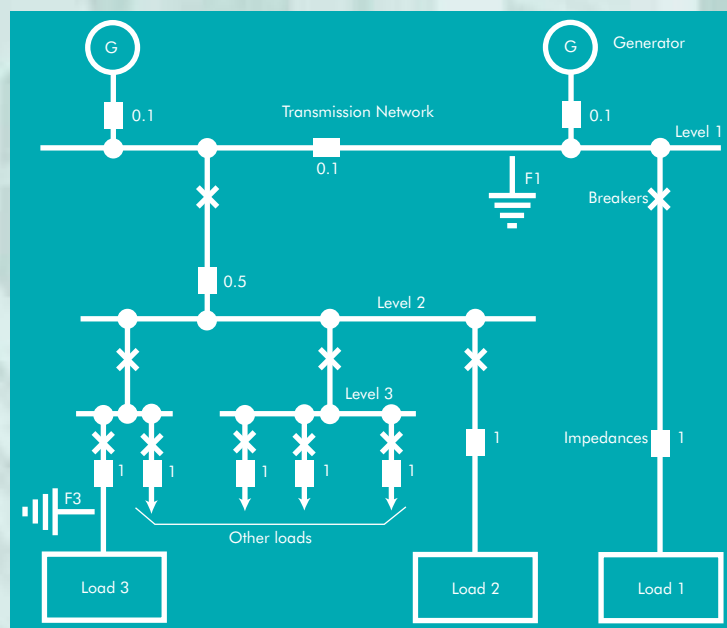

Voltage Dips *Introduction*

5.1

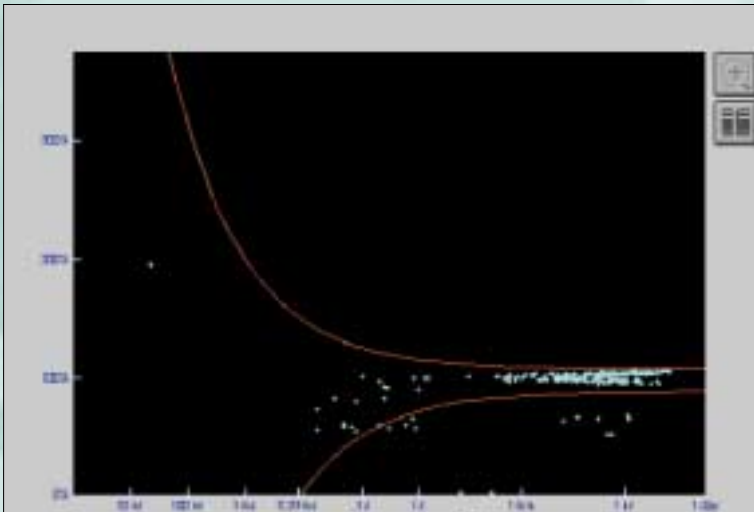

Voltage Dips

Introduction

David Chapman
Copper Development Association
March 2001

(Version 0b November 2001)

European Copper Institute (ECI)

The European Copper Institute is a joint venture between ICA (International Copper Association) and IWCC (International Wrought Copper Council) contributing members. Through its membership, ECI acts on behalf of the world's largest copper producers and Europe's leading fabricators in promoting copper in Europe. Formed in January 1996, ECI is supported by a network of ten Copper Development Associations ('CDAs') in Benelux, France, Germany, Greece, Hungary, Italy, Poland, Scandinavia, Spain and the UK. It furthers the efforts initially undertaken by the Copper Products Development Association, formed in 1959, and INCRA (International Copper Research Association) formed in 1961.

Copper Development Association (CDA)

Copper Development Association is a non-trading organisation sponsored by the copper producers and fabricators to encourage the use of copper and copper alloys and to promote their correct and efficient application. Its services, which include the provision of technical advice and information, are available to those interested in the utilisation of copper in all its aspects. The Association also provides a link between research and the user industries and maintains close contact with the other copper development organisations throughout the world.

Acknowledgement

This project has been carried out with the support of the European Community and International Copper Association, Ltd.

Acknowledgements are due to Eric Lewis of Alstom Drives and Controls Ltd for his contribution of material and useful suggestions.

Disclaimer

European Copper Institute and Copper Development Association disclaim liability for any direct, indirect, consequential or incidental damages that may result from the use of the information, or from the inability to use the information or data contained within this publication.

Copyright© European Copper Institute and Copper Development Association.

Reproduction is authorised providing the material is unabridged and the source is acknowledged.

Copper Development Association

Copper Development Association
Verulam Industrial Estate
224 London Road
St Albans AL1 1AQ
United Kingdom

Tel: 00 44 1727 731200
Fax: 00 44 1727 731216
Email: copperdev@compuserve.com
Websites: www.cda.org.uk and www.brass.org



European Copper Institute
168 Avenue de Tervueren
B-1150 Brussels
Belgium

Tel: 00 32 2 777 70 70
Fax: 00 32 2 777 70 79
Email: eci@eurocopper.org
Website: www.eurocopper.org

Voltage Dips

Introduction

A voltage dip is a short-term reduction in, or complete loss of, RMS voltage. It is specified in terms of **duration** and **retained voltage**, usually expressed as the percentage of nominal RMS voltage remaining at the lowest point during the dip. A voltage dip means that the required energy is not being delivered to the load and this can have serious consequences depending on the type of load involved.

Voltage sags - longer-term reductions in voltage – are usually caused by a deliberate reduction of voltage by the supplier to reduce the load at times of maximum demand or by an unusually weak supply in relation to the load.

Motor drives, including variable speed drives, are particularly susceptible because the load still requires energy that is no longer available except from the inertia of the drive. In processes where several drives are involved individual motor control units may sense the loss of voltage and shut down the drive at a different voltage level from its peers and at a different rate of deceleration resulting in complete loss of process control. Data processing and control equipment is also very sensitive to voltage dips and can suffer from data loss and extended downtime. The cost implications are very serious and are discussed in Section 2.

There are two main causes of voltage dips; starting of large loads either on the affected site or by a consumer on the same circuit and faults on other branches of the network.

Dips caused by large loads

When heavy loads are started, such as large drives, the starting current can be many times the normal running current. Since the supply and the cabling of the installation are dimensioned for normal running current the high initial current causes a voltage drop in both the supply network and the installation. The magnitude of the effect depends on how 'strong' the network is, that is, how low the impedance is at the point of common coupling (PCC) and on the impedance of the installation cabling. Dips caused by starting currents are characterised by being less deep and much longer than those caused by network faults – typically from one to several seconds or tens of seconds, rather than less than one second.

On-site problems, caused by too high resistance in the internal cabling, are easily dealt with. Large loads should be wired directly back to the origin of the appropriate voltage level – either the PCC or the secondary of the supply transformer. If the problem is caused by the impedance of the PCC – i.e. the supply is too 'weak' – then further action is required. One solution, if applicable to the equipment in question, is to fit a soft starter so that the starting current is limited to a lower value but is required for rather longer. Another

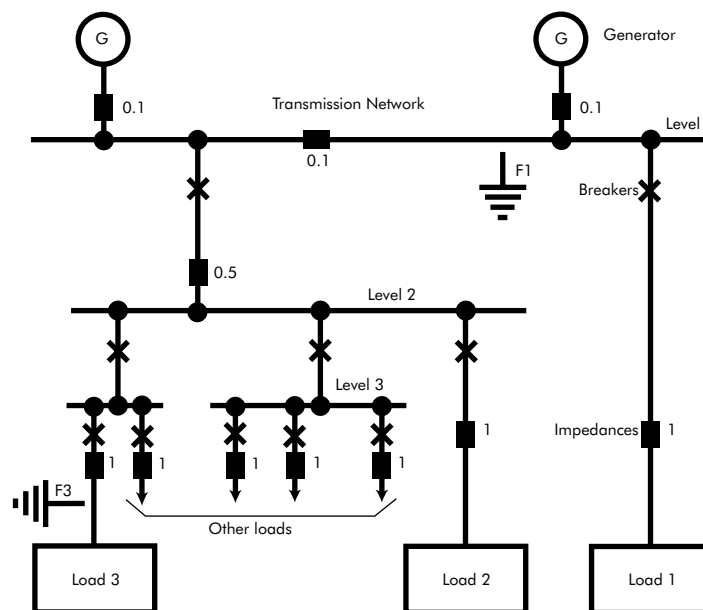

Figure 1 - The cause of voltage dips

Introduction

solution is to negotiate with the supply company for a lower impedance connection – but this may be expensive depending on the geography of the network in the area. If the cause of the voltage reduction cannot be controlled, then other equipment will be needed to compensate for it. Suitable equipment ranges from the traditional servo controlled mechanical stabilisers to electronically controlled tap changers and dynamic voltage restorers. These types of equipment are discussed in Section 5.3.

Dips originating from network faults

The supply network is very complex. The extent of a voltage dip at one site due to a fault in another part of the network depends on the topology of the network and the relative source impedances of the fault, load and generators at their common point of coupling. Figure 1 shows an example.

A fault at position F3 results in a dip to 0 % at Load 3, a dip to 64 % at Load 2 and to 98 % at Load 1. A fault at F1 will affect all users with a dip to 0 % at Load 1 and to 50 % for all other loads. Notice that a fault at Level 1 affects many more consumers more severely than a fault at Level 3. Loads connected at Level 3 are likely to experience many more dips than a load connected at Level 1 because there are more potential fault sites – they are affected by Level 1 and level 2 faults. Loads at Level 2 and 1 are progressively less sensitive to faults at Level 3. The ‘closer’ the load is to the source, the fewer and the less severe the dips will be.

The duration of the dip depends on the time taken for the protective circuits to detect and isolate the fault and is usually of the order of a few hundred milliseconds. Since faults can be transitory, for example when caused by a tree branch falling onto a line, the fault can be cleared very soon after it has occurred. If the circuit were to be permanently disconnected by the protection equipment then all consumers on the circuit would experience a blackout until the line could be checked and reconnected. Autoreclosers can help to ease the situation, but also cause an increase in the number of dips. An autorecloser attempts to reconnect the circuit a short time (less than 1 second) after the protection equipment has operated. If the fault has cleared, the autoreclose will succeed and power is restored. Loads on that circuit experience a 100 % dip between disconnection and autoreclose while other loads see a smaller, shorter dip between the fault occurring and being isolated, as discussed above. If the fault has not cleared when the autorecloser reconnects, the protective equipment will operate again; the process can be repeated according to the program set for the particular autorecloser. Each time the autorecloser reconnects the faulty line another dip results, so that other consumers can experience several dips in series. Utility performance in deregulated markets is partly - in some countries, such as UK, solely - judged on the average ‘customer minutes lost’, taking into account interruptions exceeding, typically, one minute. Minimising this statistic has resulted in the widespread application of autoreclosers and an increase in the probability of dips. In other words, long term availability has been maximised but at the expense of quality.

Equipment sensitivity

Computers are now essential to all businesses, whether as workstations, network servers or as process controllers. They are vital to all data processing transactions and many communications functions, such as e-mail and voice box systems. It was the introduction of computer equipment that first highlighted the problem of voltage dips (in fact, most power quality problems) and early installations were plagued with seemingly random failures that resulted in considerable support effort being required. The learning process resulted in the production of the Computer and Business Equipment Manufacturers Association (CBEMA) curve (Figure 2). This curve has since been modified and is now known as the Information Technology Industry Council (ITIC) curve (Figure 3) and a version of it has been standardised by ANSI as IEEE 446 (Figure 4).

Duration of an event is plotted against voltage with respect to the nominal supply voltage and the curves define the envelope within which equipment should continue to function without interruption or data loss. As far as dips are concerned it is the lower limit line that is of interest. This line represents the boundary between survivable and non-survivable dips.

In an ideal world there would be just one curve that represented real-world supply network performance and to which all equipment would comply. In fact, while quite a lot of equipment meets the requirement of one or other of the standard curves, the performance of supply networks falls far short.

Introduction

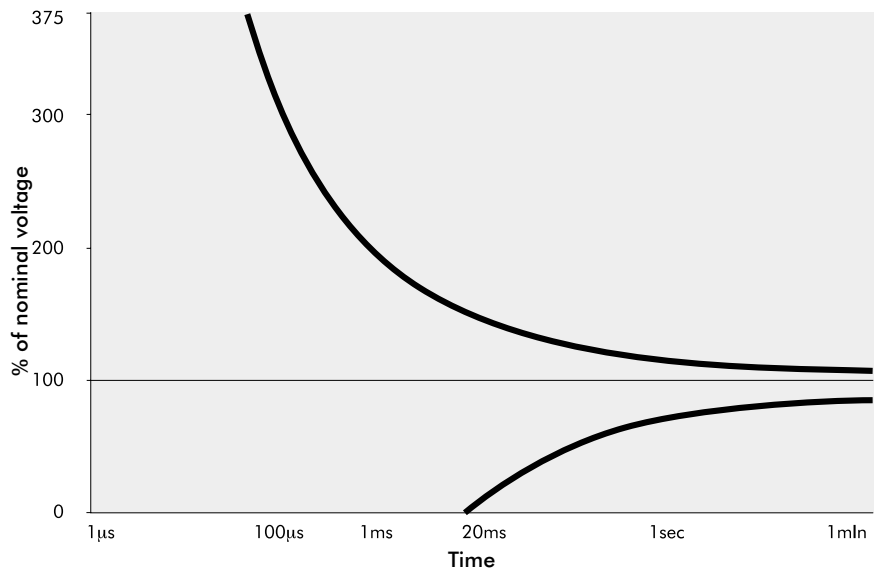

Figure 2 - CBEMA curve

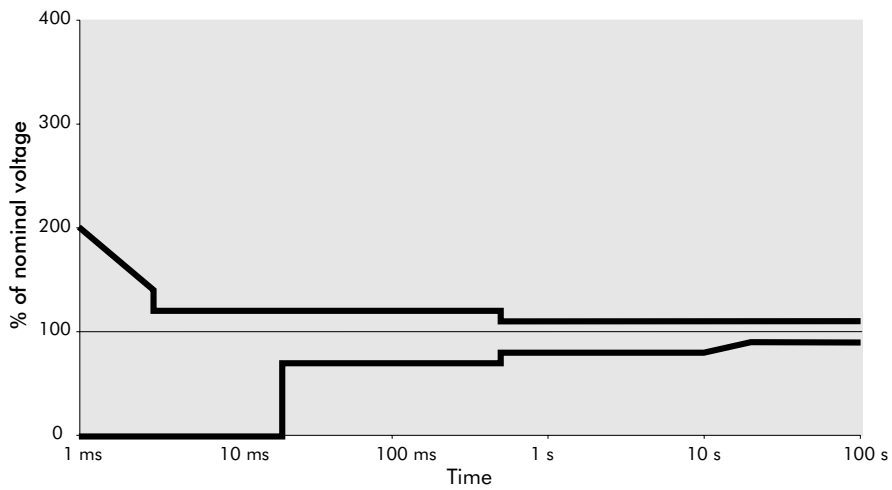

Figure 3 - ITIC curve

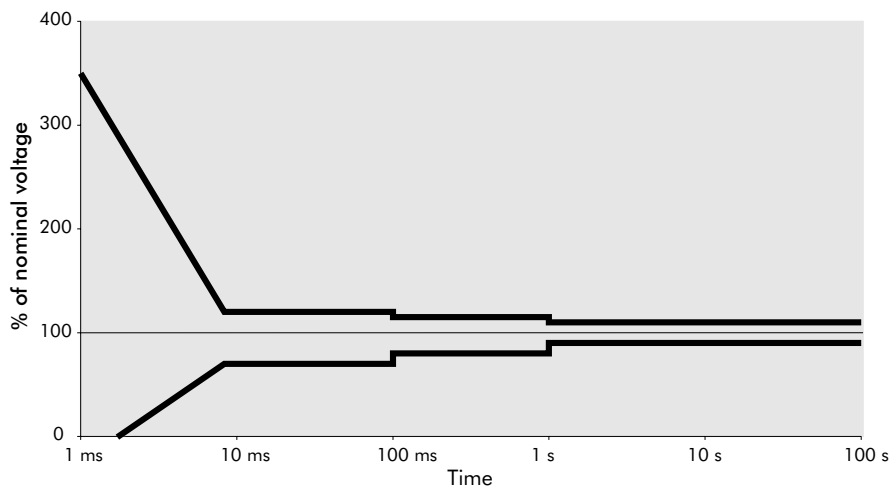

Figure 4 - ANSI curve

Introduction

Characteristics of equipment sensitivity

Electronic equipment power supplies, such as those used in personal computers (PC) and programmable logic controllers (PLC) employ a reservoir capacitor to smooth out the peaks of the full wave rectified waveform, so they should be inherently resilient to short duration dips. The larger the capacitor, and the greater the difference between the stored capacitor voltage and the minimum required for the internal voltage converters to operate, the better the resilience will be. Designers will always try to reduce the size of the capacitor to a minimum to reduce size, weight and cost while ensuring that the charge stored is just sufficient at minimum voltage and maximum load. For good dip resilience a much larger capacitor is required, at least twice as large to enable the equipment to ride through one cycle, and 100 times as large if a one-second ride through was required. An alternative design strategy is to keep the minimum input voltage as low as possible to maximise the hold up time of the system. This is the approach taken, by default, in equipment designed to work over a wide range of voltage. The hold up time will be much greater with a 230 V supply than it will be with a 110 V supply. There is no technical problem in making a dip resistant power supply but it is not done because it is not an issue that users raise with manufacturers and there are cost implications. Nevertheless, the cost of making a PC or PLC resilient to 1 second dips is very small compared to the cost of improving the network assets to prevent such a dip occurring.

Variable speed drives can be damaged by voltage dips and are usually fitted with under voltage detectors that trip at 15 % to 30 % below nominal voltage. Variable speed drives with enhanced ride through capability are the subject of a later section of this Guide.

Induction motors have inertia so they may help to support the load during a short dip, regenerating energy as they slow down. This energy has to be replaced as the motor re-accelerates and, if the speed has reduced to less than 95 %, it will draw nearly the full start-up current. Since all the motors are 'starting' together, this may be the cause of further problems.

Relays and contactors are also sensitive to voltage dips and can often be the weakest link in the system. It has been established that a device may drop out during a dip even when the retained voltage is higher than the minimum steady state hold-in voltage. The resilience of a contactor to dips depends not only on the retained voltage and duration but also on the point on the waveform where the dip occurs, the effect being less at the peak.

Sodium discharge lamps have a much higher striking voltage when hot than cold, so that a hot lamp may not restart after a dip. The magnitude of dip that will cause a lamp to extinguish may be as little as 2 % at the end of life or as high as 45 % when new.

Most appliances and systems incorporate one or more of the above elements, and so will exhibit problems when subject to dips. Figure 5, below, suggests that it is cheaper and more reliable to design equipment to be resilient to dips, rather than to try to make the whole process, whole plant, or the whole electricity distribution system resilient. As shown here, the cost of solution increases rapidly as the point of cure is moved from equipment through plant to infrastructure.

Characteristics of supply dips

As pointed out above, the probability of voltage dips occurring, and their likely magnitude, depends on the topology of the network in the vicinity of the site in question. There have been some limited studies in relatively small areas in some countries, but it is still true to say that dip statistics for particular locations are not available. This makes the selection of a site for a critical operation difficult. Obviously, a site close to a generating station (or two) and connected at medium voltage by underground cable will be a better choice than a remote site with a long exposed overhead connection, but to what extent? It is easy to judge the quality of transport links, for example, and that factor is often cited as a reason for selecting a particular business location, but it is rather more difficult to judge the quality of the electrical infrastructure.

Green field sites present special problems since there are no existing plants as a reference. On the other hand, they do represent an opportunity to start out with an adequate infrastructure in place, as long as the local supply company is willing and able to provide it (using your money!).

Introduction

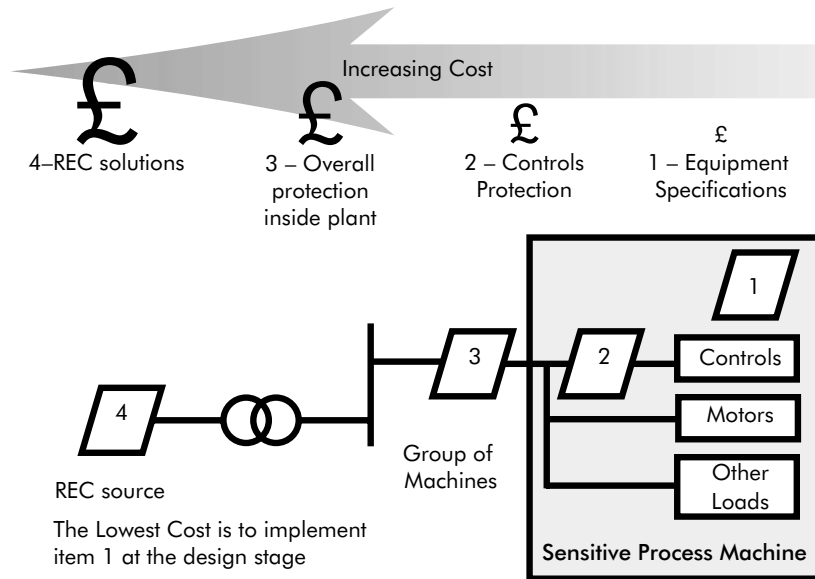

Figure 5 - Cost of improvements in dip tolerance

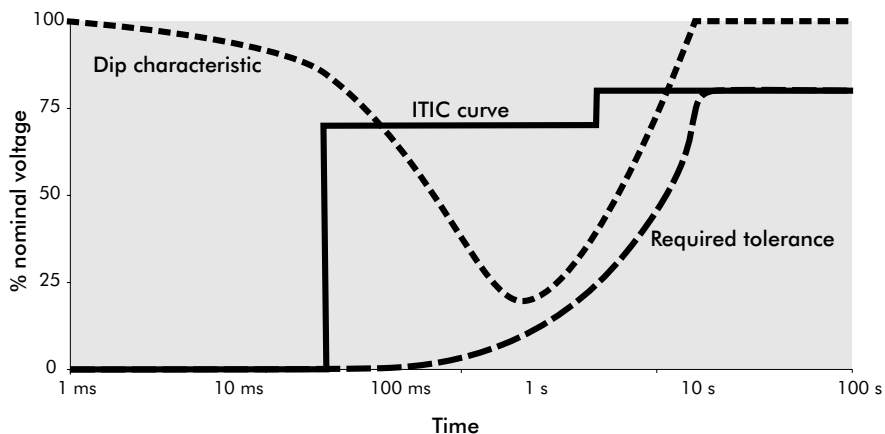

Figure 6 - Typical supply dip characteristic and ITIC curve

Those studies that have been done show that the duration of supply dips is rather longer than suggested by the equipment tolerance curves discussed above. Figure 6 shows the likely duration and magnitude of dips on a typical supply network. The ITIC curve is plotted as well for comparison.

This chart clearly shows that, in the real world, IT equipment really needs to be about 100 times better than is implied by the ITIC curve, as shown by the 'required tolerance' curve. It is probably true to say that no production equipment meets this requirement!

Bridging the gap

Clearly, in a business environment, the equipment in use has to be resilient to the normal characteristic defects of the supply and this is not the case with off-the-shelf equipment. As shown in Figure 5 the cost of correction is much lower if corrective action is taken at the design stage of the equipment but this requires knowledge of the nature and probability of defects. It is this knowledge that is missing. This is, however, the most cost effective approach.

Introduction

Some equipment makers are recognising the problem but the competitive market means that manufacturers will only respond to customers' requirements. Until customers understand the problems and realise that equipment suppliers can provide a solution, they will not specify improved performance. The exception is the variable speed drive market where manufacturers are actively promoting products with enhanced dip ride through.

The traditional approach is to provide additional equipment to support the load through the dips; the type of equipment available is detailed in later sections of this Guide. In the case of low power loads, such as IT equipment, un-interruptible power supplies have been used to protect against both dips and short interruptions. The energy store is usually a rechargeable battery so they are not suitable for long durations. Typically, the load is supported for just long enough to arrange an orderly shutdown, so protecting the data, but still requiring considerable restart time. Sometimes a UPS is used to provide power while a rotary generator is started.

For shallow dips, where there is considerable retained voltage, there are several established automatic voltage regulator technologies including electro-mechanical and electromagnetic devices. Because there is no need for stored energy, these devices can be used for long duration events such as under and over voltage. Automatic voltage regulators are discussed in Section 5.3.1 of this Guide.

Where heavy loads or deep dips are concerned a Dynamic Voltage Restorer (DVR) is used. This device is series coupled to the load and generates the missing part of the supply; if the voltage dips to 70 %, the DVR generates the missing 30 %. DVRs are normally expected to support the load for a short period and may use heavy-duty batteries, super capacitors or other forms of energy storage such as high-speed flywheels. DVRs cannot be used to correct long term under and over voltage.

Conclusion

Improving the network performance to eliminate dips is very expensive and probably impossible. In special cases, where the need justifies the expense, it may be possible to arrange for dual supplies that are derived from sufficiently separated parts of the grid as to be considered independent.

For most operations some form of dip mitigation equipment will be required and there is a wide range to choose from, depending on the type of load that is being supported.

The cheapest solution is to specify equipment with the necessary resilience to dips but this option is not yet well supported by manufacturers.

Network Partners

Copper Benelux

168 Avenue de Tervueren
B-1150 Brussels
Belgium

Tel: 00 32 2 777 7090
Fax: 00 32 2 777 7099
Email: mail@copperbenelux.org
Web: www.copperbenelux.org

Contact: Mr B Dôme

Copper Development Association

Verulam Industrial Estate
224 London Road
St Albans AL1 1AQ
United Kingdom

Tel: 00 44 1727 731205
Fax: 00 44 1727 731216
Email: copperdev@compuserve.com
Webs: www.cda.org.uk & www.brass.org

Contact: Mrs A Vessey

Deutsches Kupferinstitut e.V

Am Bonnheshof 5
D-40474 Duesseldorf
Germany

Tel: 00 49 211 4796 323
Fax: 00 49 211 4796 310
Email: sfassbinder@kupferinstitut.de
Web: www.kupferinstitut.de

Contact: Mr S Fassbinder

ECD Services

Via Cardinal Maffi 21
I-27100 Pavia
Italy

Tel: 00 39 0382 538934
Fax: 00 39 0382 308028
Email: info@ecd.it
Web: www.ecd.it

Contact: Dr A Baggini

European Copper Institute

168 Avenue de Tervueren
B-1150 Brussels
Belgium

Tel: 00 32 2 777 70 70
Fax: 00 32 2 777 70 79
Email: eci@eurocopper.org
Web: www.eurocopper.org

Contact: Mr H De Keulenaer

Hevrox

Schoebroekstraat 62
B-3583 Beringen
Belgium

Tel: 00 32 11 454 420
Fax: 00 32 11 454 423
Email: info@hevrox.be

Contact: Mr I Hendrikx

HTW

Goebenstrasse 40
D-66117 Saarbruecken
Germany

Tel: 00 49 681 5867 279
Fax: 00 49 681 5867 302
Email: wlang@htw-saarland.de

Contact: Prof Dr W Langguth

Istituto Italiano del Rame

Via Corradino d'Ascanio 4
I-20142 Milano
Italy

Tel: 00 39 02 89301330
Fax: 00 39 02 89301513
Email: ist-rame@wirednet.it
Web: www.iir.it

Contact: Mr V Loconsolo

KU Leuven

Kasteelpark Arenberg 10
B-3001 Leuven-Heverlee
Belgium

Tel: 00 32 16 32 10 20
Fax: 00 32 16 32 19 85
Email: ronnie.belmans@esat.kuleuven.ac.be

Contact: Prof Dr R Belmans

Polish Copper Promotion Centre SA

Pl.1 Maja 1-2
PL-50-136 Wroclaw
Poland

Tel: 00 48 71 78 12 502
Fax: 00 48 71 78 12 504
Email: copperpl@wroclaw.top.pl

Contact: Mr P Jurasz

TU Bergamo

Viale G Marconi 5
I-24044 Dalmine (BG)
Italy

Tel: 00 39 035 27 73 07
Fax: 00 39 035 56 27 79
Email: graziana@unibg.it

Contact: Prof R Colombi

TU Wroclaw

Wybrzeze Wyspianskiego 27
PL-50-370 Wroclaw
Poland

Tel: 00 48 71 32 80 192
Fax: 00 48 71 32 03 596
Email: i8@elektryk.ie.pwr.wroc.pl

Contact: Prof Dr H Markiewicz



David Chapman

 **Copper Development Association**

Copper Development Association
Verulam Industrial Estate
224 London Road
St Albans AL1 1AQ
United Kingdom

Tel: 00 44 1727 731200
Fax: 00 44 1727 731216
Email: copperdev@compuserve.com
Websites: www.cda.org.uk
www.brass.org

 **Copper Development Association**

Copper Development Association
Verulam Industrial Estate
224 London Road
St Albans AL1 1AQ
United Kingdom

Tel: 00 44 1727 731200
Fax: 00 44 1727 731216
Email: copperdev@compuserve.com
Websites: www.cda.org.uk and www.brass.org



European Copper Institute
168 Avenue de Tervueren
B-1150 Brussels
Belgium

Tel: 00 32 2 777 70 70
Fax: 00 32 2 777 70 79
Email: eci@eurocopper.org
Website: www.eurocopper.org